

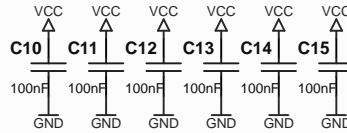

### Bypass Capacitors

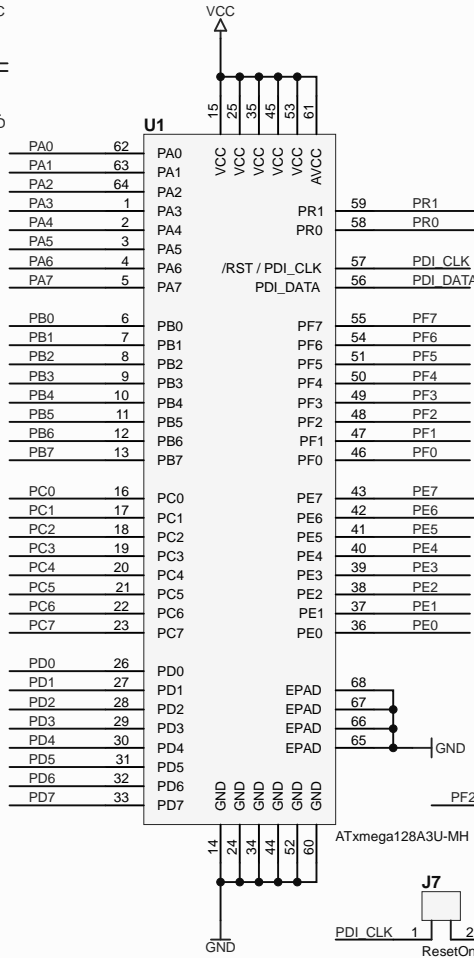

### Xmega Microcontroller



### microSD Card Header

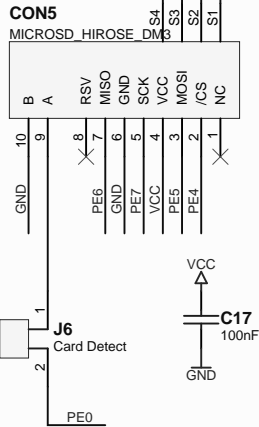

### Reset Push Button

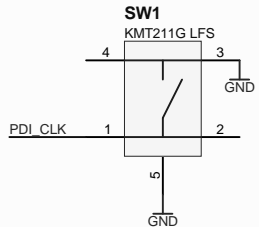

### Reset pullup resistor

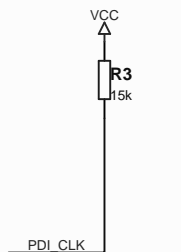

### Status LED

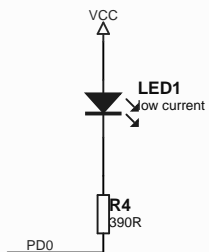

### ISP PDI Connector

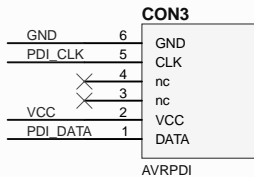

### Low Drop 3.3V Regulator (200mA)

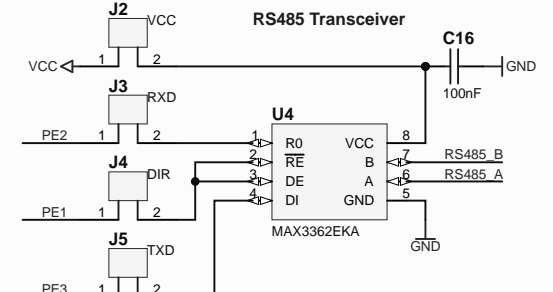
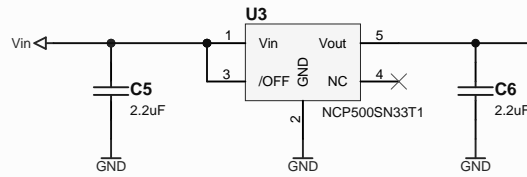

### XTAL and TOSC Crystals

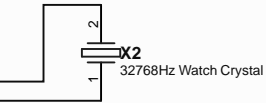

### USB-UART converter

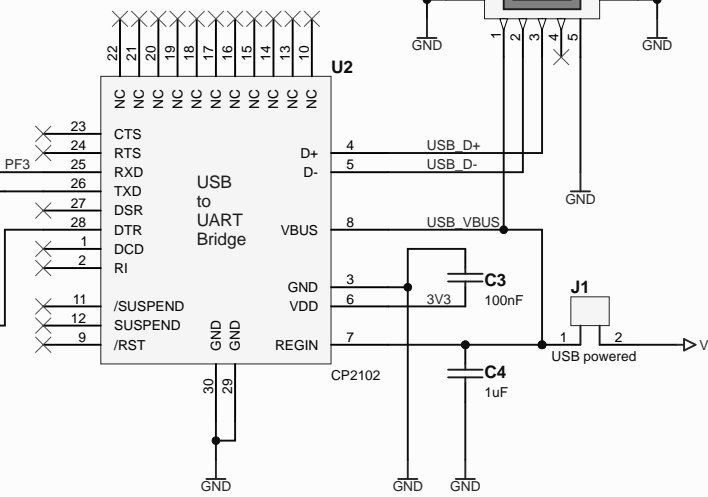

### Mini 5-pin USB-B connector

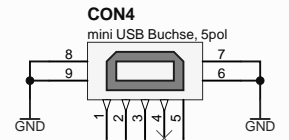

Project  
Module with ATxmega128A3U, USB, RS485, LDO

Name  
CrumbX128A3

Date:	03.05.2022	Modified:		Version	1.5
Author:	Dr. Erik Lins				
File:	CrumbX256A3.sch				1 von 1

chip45 GmbH & Co. KG  
http://www.chip45.com

