

Monitoring cameras



Dome type monitoring cameras



Inner-city monitoring cameras

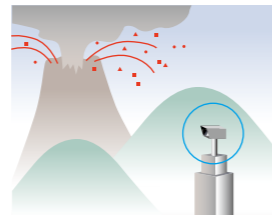

Disaster prevention monitoring cameras

Laboratory cabinets



Cabinets for storing medicine and optical parts

Optical application equipment



Laser processing machines

Telecommunications

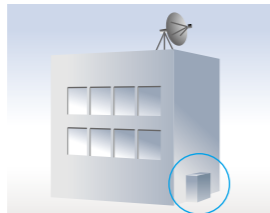

Mobile phone shelters

OA equipment

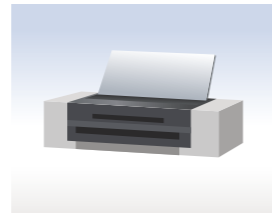

High quality image printers

Analyzers

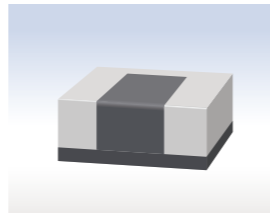

Infrared spectrographs (FT-IR)

Road facilities

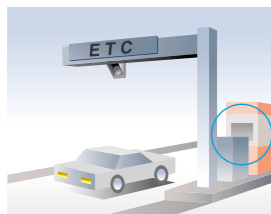

ETCS control panels

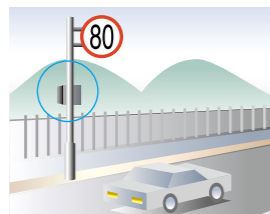

Automatic speed indicators

Electric facilities

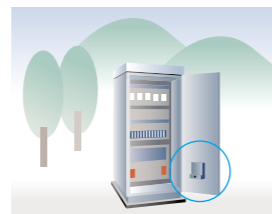

Monitoring control panels

Production facilities

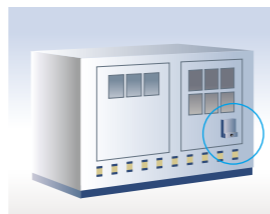

NC control panels

Intellectual property right

The basic patent of dehumidifier using this system is reserved by Mitsubishi Electric Corp.

Our company acquires its patent license, and is also applying for the relevant patents in cooperation with Mitsubishi Electric Corp.

CAUTION

- Prior to use, carefully read the instruction manual attached to the product.
- The specifications described in this brochure, such as the rating, dimensions and appearance, may be subject to changes without prior notice; it is, therefore, necessary to purchase our product after it has been checked satisfactorily at your end.



Available worldwide from:
Westside International Ltd.
Farbeld House, Station Road.
Grove. OX12 7PE
United Kingdom
 +44 (0)203 286 8189
 www.micro-dehumidifier.com
 enquiries@westside-int.com

The protective apparatus against dew condensation

Electrolysis type Dehumidifying element / Dehumidifier ROSAHL



— A new standard for a new era —

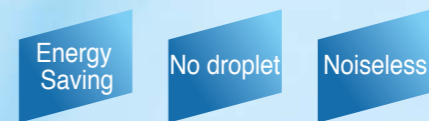

ROSAHL

Completely new approach to dehumidification

World's first electrolytic method



This product uses a solid polymer electrolyte membrane, a completely different principle from conventional dehumidification methods. It directly electrolyzes and removes moisture from the air, and provides many advantages (see below).
(The name "ROSAHL" comes from a pun on a Japanese phrase meaning "removing dew".)



- This new type of dehumidifier electrolytically decomposes and removes moisture in a container using a solid polymer electrolyte membrane.
- When a direct current is applied to the porous electrode attached to the special solid polymer electrolyte membrane, moisture at the anode side (dehumidifying side) is separated into hydrogen ions (H⁺) and oxygen. The hydrogen ions pass through the solid polymer electrolyte membrane to the cathode side (moisture discharging side).
- The hydrogen ions react with oxygen in the air on the cathode side to form water molecules (gas) and are then discharged.



1. Energy saving
2. No droplet
3. Capable of dehumidifying even below 0°C or less
4. Noiseless
5. Compact and lightweight
6. Works also as a humidifier

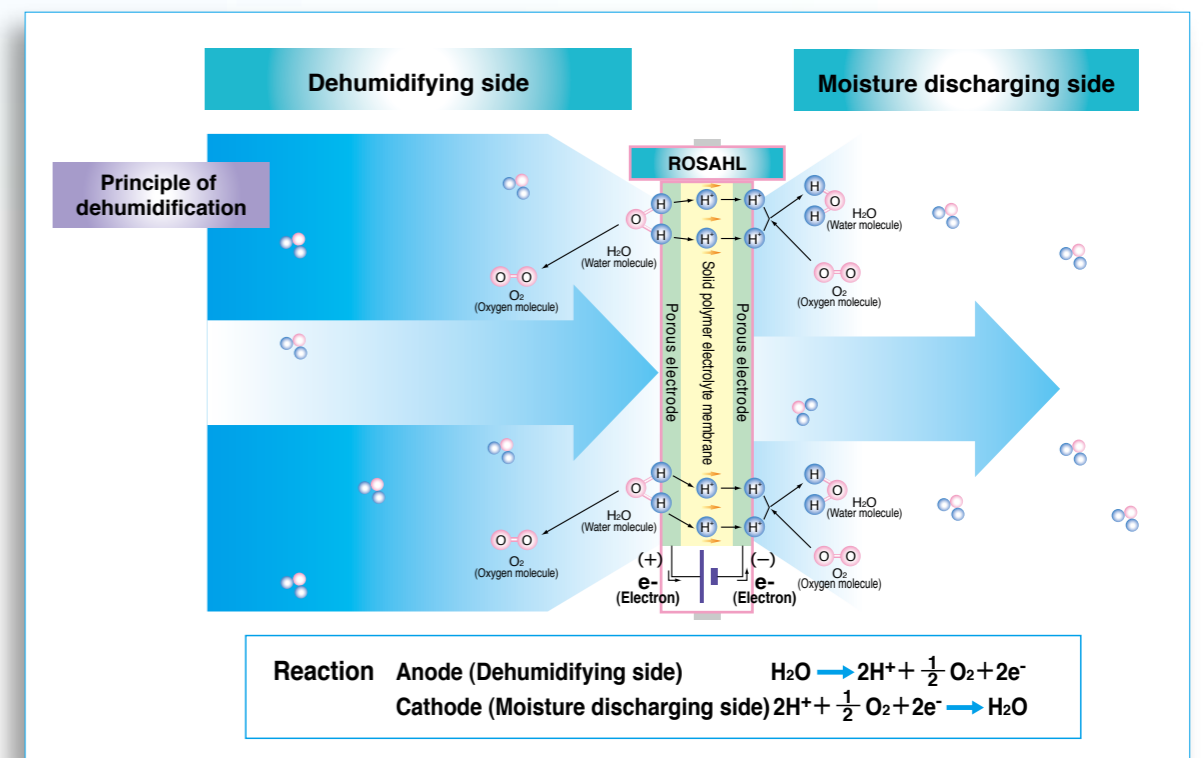

Small Dehumidifying Element

Installation is simple in small size !

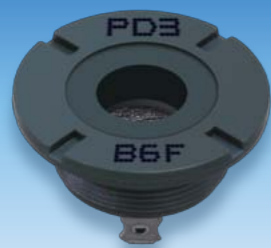

PD3

Small Dehumidifying Element

Compact body as small as your thumb!



RD3

Thin Dehumidifying Element

Only 2.3 mm thick!



MDL-5

Specifications

Figure 1 External dimensions (Unit:mm)

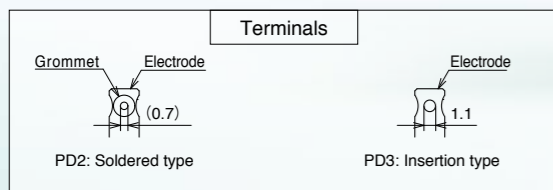
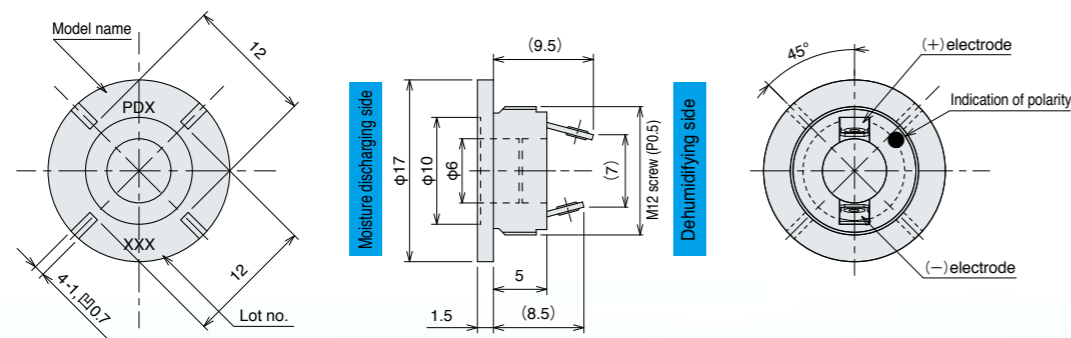
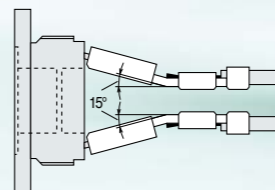

Figure 2 Example installation of insertion type terminal



Model name	PD2/PD3
Dehumidifying capacity (mg/day) *1	84
Applicable volume (cc) *2	Up to 2000
Element terminal voltage (V)	3 VDC
Power consumption (mW) *3	80
Dimensions (mm) *4	φ17×11
Weight (g)	0.9
Dimensions of installation hole (mm) *5	M12 screw (P0.5)
Operating temperature (°C)	-10 to 50
Element connecting terminal type *6	PD2:Soldered type. PD3:Insertion type

- Notes *1 The initial value at the temperature of 30°C and humidity of 60%. (The dehumidifying capacity will degrade during use. How much it degrades depends on the operating environment and conditions. If any signs of abnormality are seen, early replacement is recommended.)
- *2 The applicable volume is for a sealed, moisture-impermeable container, and may vary depending on the material of the container, state of sealing and required humidity.
- *3 The annual average power consumption in average conditions in Japan.
- *4 See Figure 1.
- *5 See installation instructions on page 10.
- *6 For an insertion type terminal for PD3, use a STO-01T-110N (JST) flat connecting terminal or equivalent. The insertion type terminals may touch each other, as the element bodies are small. See Figure 2 for installation.

Read the precautions for use on page 14.

Specifications

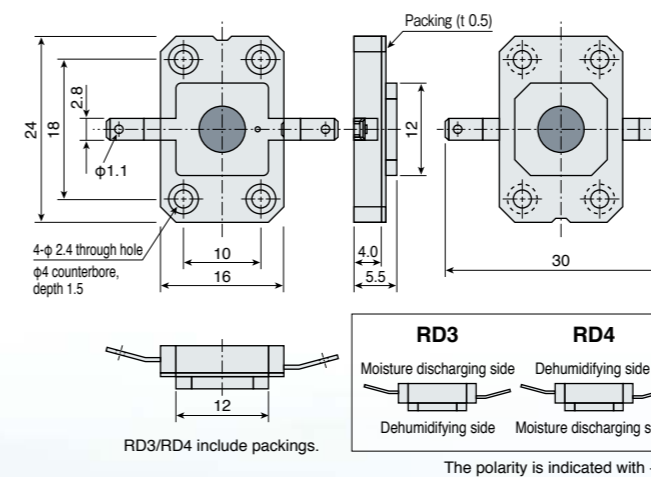

Model name	RD3/RD4 *6
Dehumidifying capacity (mg/day) *1	84
Applicable volume (cc) *2	Up to 2000
Element terminal voltage (V)	3 VDC
Power consumption (mW) *3	80
Dimensions (height x width x depth) (mm)	24 x 30 x 5.5
Weight (g)	1.9
Dimensions of moisture discharging hole (mm) *4	12.5 x 12.5
Operating temperature (°C)	-10 to 50
Element connecting terminal type *5	Soldered type or Insertion type

- Notes *1 The initial value at the temperature of 30°C and humidity of 60%. (The dehumidifying capacity will degrade during use. How much it degrades depends on the operating environment and conditions. If any signs of abnormality are seen, early replacement is recommended.)
- *2 The applicable volume is for a sealed, moisture-impermeable container, and may vary depending on the material of the container, state of sealing and required humidity.
- *3 The annual average power consumption in average conditions in Japan.
- *4 See installation instructions on page 10.
- *5 For an insertion type terminal, use a STO-01T-110N (JST) flat connecting terminal or equivalent.
- *6 When dehumidifying the inside of a container, attach RD3 from the outside or RD4 from the inside.

Read the precautions for use on page 14.

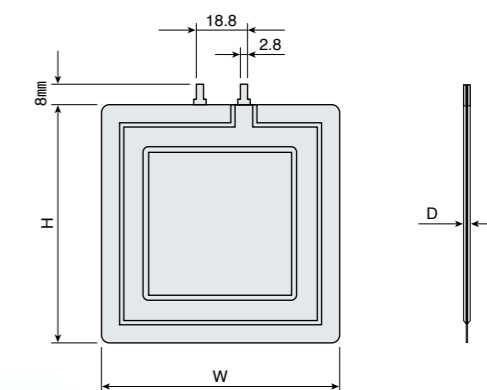

The polarity is indicated with +/-.

Model name	MDL-3	MDL-5	MDL-7
Dehumidifying capacity (g/day) *1	4	8	16
Applicable volume (m³) *2	Up to 0.5	Up to 1	Up to 2
Element terminal voltage (V)	3 VDC		
Power consumption (W) *3	2	3	4
Dimensions (height x width x depth) (mm)	88 x 63 x 2.3	88 x 88 x 2.3	108 x 108 x 2.3
Weight (g)	Approx. 20	Approx. 25	Approx. 50
Dimensions of moisture discharging hole (mm) *4	55 x 30	55 x 55	75 x 75
Operating temperature (°C)	-10 to 50		
Element connecting terminal type	(+ side: STO-41T-110N (JST) or equivalent (-) side: STO-41T-110N-8 (JST) or equivalent		

- Notes *1 The initial value at the temperature of 30°C and humidity of 60%. (The dehumidifying capacity will degrade during use. How much it degrades depends on the operating environment and conditions. If any signs of abnormality are seen, early replacement is recommended.)
- *2 The applicable volume is for a sealed, moisture-impermeable container, and may vary depending on the material of the container, state of sealing and required humidity.
- *3 The annual average power consumption in average conditions in Japan.
- *4 See installation instructions on page 11.

Read the precautions for use on page 14.

Molded Type Dehumidifier

Lightweight body!

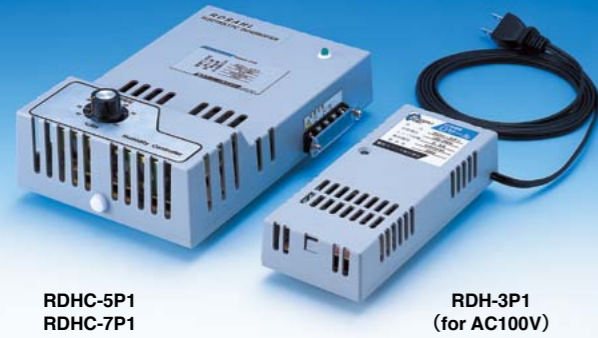

RDHC-5P1
RDHC-7P1

RDH-3P1
(for AC100V)

Separate Type Dehumidifier

Can be used for 100 or 200 VAC!



Power supply unit

Humidity controller unit

Element unit

Humidity Controller Embedded Dehumidifier

Energy saving by setting your desired humidity!



RDHC-7J1

General Dehumidifier



RDH-7J1

Specifications

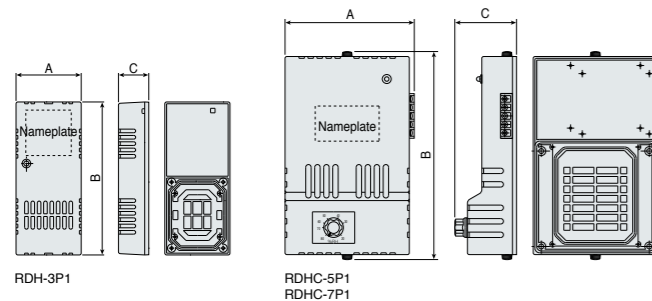

RDH-3P1

RDHC-5P1
RDHC-7P1

Model name	RDH-3P1	RDHC-5P1	RDHC-7P1
Dehumidifying capacity (g/day) *1	2.9	8	16
Applicable volume (m ³) *2	Up to 0.35	Up to 1	Up to 2
Rated voltage (V)	100/200 VAC	100 VAC	
Power consumption (W) *3	3	4	5
Dielectric strength (V)	2000 AC (per minute)		
Dimensions (mm) *4	72 x 169 x 34	144 x 231 x 69	
Humidity set range (%RH) *5	—	20 to 80	
Weight (kg)	0.25	0.65	0.85
Operating temperature (°C)	-10 to 50		

* The RDH-3P1 shown in the picture is for 100 VAC.

Standard units for 200 VAC are equipped with a crimping terminal (R1.25-4) for end treatment of the power cable.

Specify 100 VAC or 200 VAC when ordering.

Notes*1 The initial value at the temperature of 30°C and humidity of 60%.

(The dehumidifying capacity will degrade during use. How much it degrades depends on the operating environment and conditions. If any signs of abnormality are seen, early replacement is recommended.)

*2 The applicable volume is for a sealed, moisture-impermeable container, and may vary depending on the material of the container, state of sealing and required humidity.

*3 The annual average power consumption in average conditions in Japan.

*4 The dimensions of A x B x C in the figure.

(The height of the knob on the RDHC type or humidity controller unit is 15 mm.)

*5 RDH-3P1 does not include a humidity controller.

*6 The power consumption when the rated load is applied.

(See the power supply unit.)

*7 The value in () is the rated output current.(See the power supply unit.)

■The element unit and power supply unit are supplied in a set.
Use the model number below to order.

Set model no.	RDHB-5J1	RDHB-7J1	RDHB-10J1
Element unit	S-5J1	S-7J1	S-10J1
Power supply unit	D-3006JW		D-3010JW

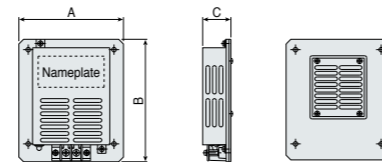

Model name	S-5J1	S-7J1	S-10J1
Dehumidifying capacity (g/day) *1	8	16	29
Applicable volume (m ³) *2	Up to 1	Up to 2	Up to 4
Element terminal voltage (V)	3 VDC		
Power consumption (W) *3	3	4	8
Dimensions (mm) *4	111 x 130 x 30	138 x 150 x 30	168 x 185 x 30
Weight (kg)	0.4	0.5	0.7
Operating temperature (°C)	-10 to 50		

The element unit only can also be purchased.

Model name	D-3006JW	D-3010JW
Applicable device unit	S-5J1, S-7J1	S-10J1
Rated voltage (V)	85 to 264 AC	
Rated power consumption (VA) *6	24	40
Rated output voltage (V) *7	3 DC (6A)	3 DC (10A)
Dielectric strength (V)	2000 AC (per minute)	
Dimensions (mm) *4	182 x 100 x 41	225 x 100 x 41
Weight (kg)	0.7	0.9
Operating temperature (°C)	-10 to 50	

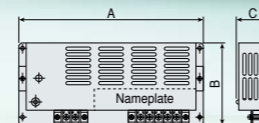

Model name	C-M1J
Dielectric strength (V)	2000 AC (per minute)
Dimensions (mm) *4	78 x 112 x 50
Weight (kg)	0.2
Humidity set range (%RH)	20 to 80
Operating temperature (°C)	-10 to 50

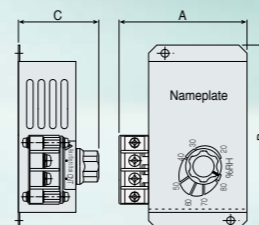

Specifications

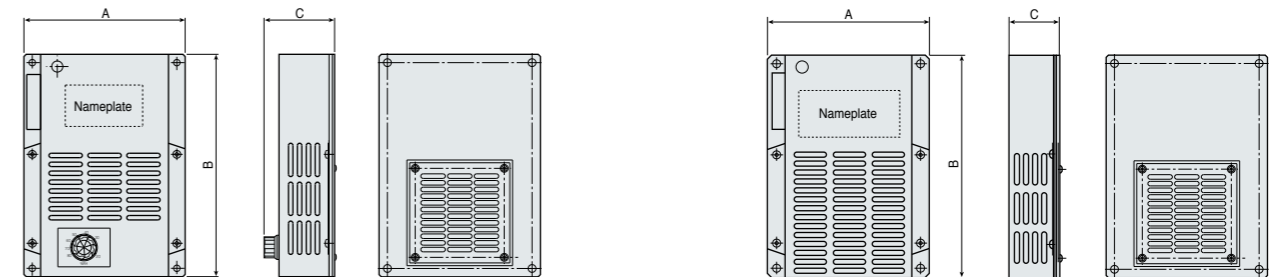

Model name	RDHC-5J1	RDHC-7J1	RDHC-10J1	RDHC-10J2
Dehumidifying capacity (g/day) *1	8	16	29	58
Applicable volume (m ³) *2	Up to 1	Up to 2	Up to 4	Up to 8
Rated voltage (V)	100/110 AC		100/110 AC	
Power consumption (W) *3	4	5	10	20
Dielectric strength (V)	2000 AC (per minute)		2000 AC (per minute)	
Dimensions (mm) *4	115 x 170 x 65	145 x 200 x 65	175 x 245 x 70	195 x 370 x 70
Humidity set range (%RH)	20 to 80		20 to 80	
Weight (kg)	0.9	1.1	1.4	2.1
Operating temperature (°C)	-10 to 50		-10 to 50	

Model name	RDH-3J1	RDH-5J1	RDH-7J1	RDH-10J1	RDH-10J2
Dehumidifying capacity (g/day) *1	4	8	16	29	58
Applicable volume (m ³) *2	Up to 0.5	Up to 1	Up to 2	Up to 4	Up to 8
Rated voltage (V)	100/110 AC		100/110 AC		
Power consumption (W) *3	3	4	5	10	20
Dielectric strength (V)	2000 AC (per minute)	2000 AC (per minute)	2000 AC (per minute)	2000 AC (per minute)	2000 AC (per minute)
Dimensions (mm) *4	81.5 x 193 x 35	115 x 170 x 45	145 x 200 x 45	175 x 245 x 55	195 x 370 x 55
Weight (kg)	0.5	0.8	1.0	1.3	2.0
Operating temperature (°C)	-10 to 50		-10 to 50		

Notes*1 The initial value at the temperature of 30°C and humidity of 60%.

(The dehumidifying capacity will degrade during use. How much it degrades depends on the operating environment and conditions. If any signs of abnormality are seen, early replacement is recommended.)

*2 The applicable volume is for a sealed, moisture-impermeable container, and may vary depending on the material of the container, state of sealing and required humidity.

*3 The annual average power consumption in average conditions in Japan.

*4 The dimensions of A x B x C in the figure.

(The height of the knob on the RDHC type is 15 mm.)

Model Selection Guide

To select a model, use the applicable volume and required humidity graphs below as a guide.
Reference: 1) The graph shows the relationship at an outside air humidity of 90%.
2) A sealed moisture-impermeable container is used.

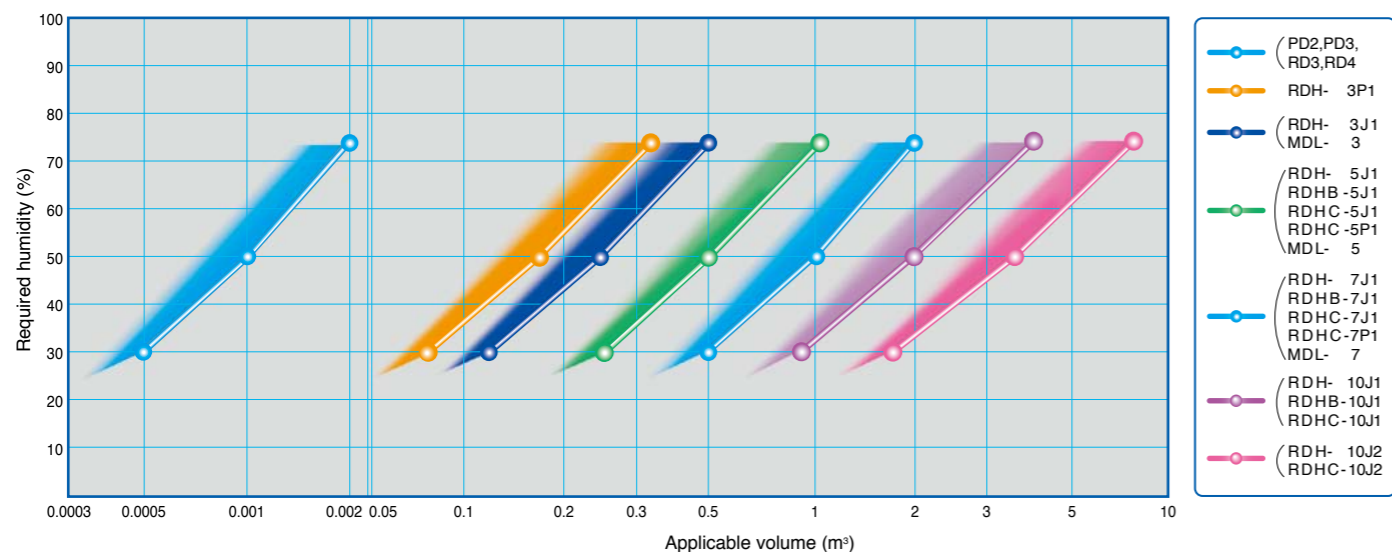

Thin dehumidifying element (MDL-3, MDL-5, MDL-7)

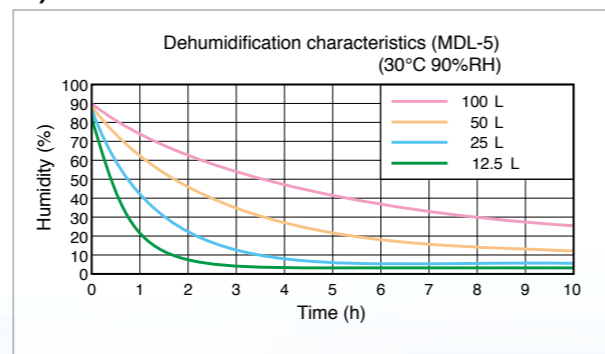
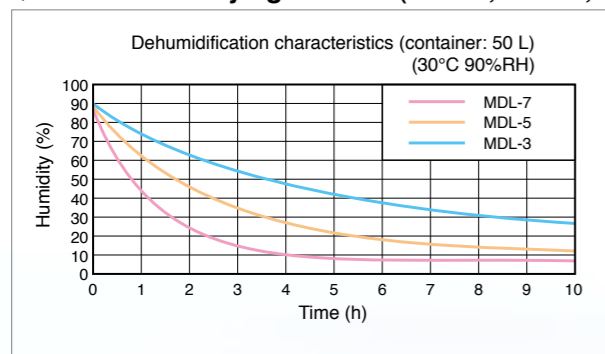

Small dehumidifying element (PD2, PD3, RD3, RD4)

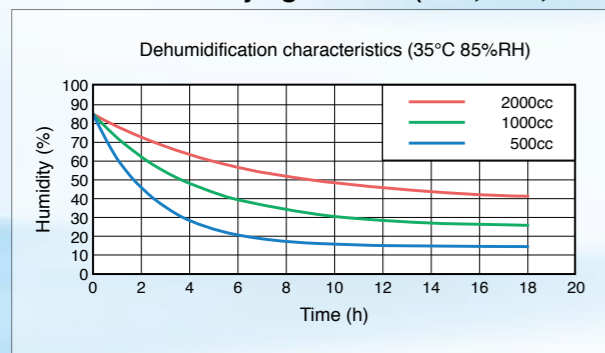

- Characteristics of the graphs may vary depending on the material of the container and the degree of airtightness.
- If the container contains moist material such as resin, dehumidifying the inside of the container induces release of moisture from the material, which will result in slow dehumidification of the inside of the container.
- The dehumidifying capacity of the element varies according to the absolute water amount inside the container.

Test data

Test data of humidity controller embedded type (RDHC-10J1)

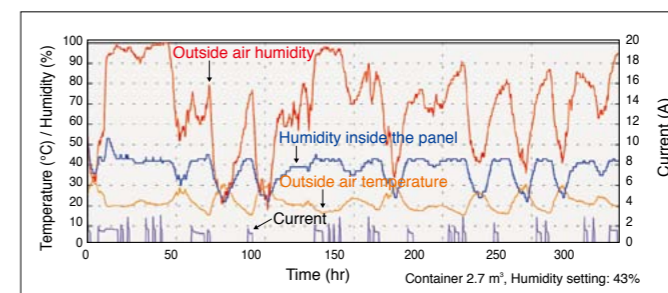

Field test data

Dehumidification results at high temperature and high humidity in summer

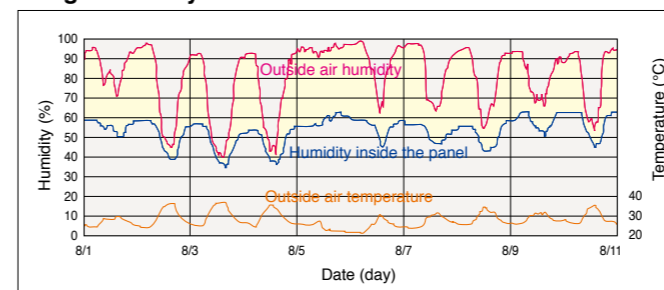

Dehumidification results at low temperature and high humidity in winter

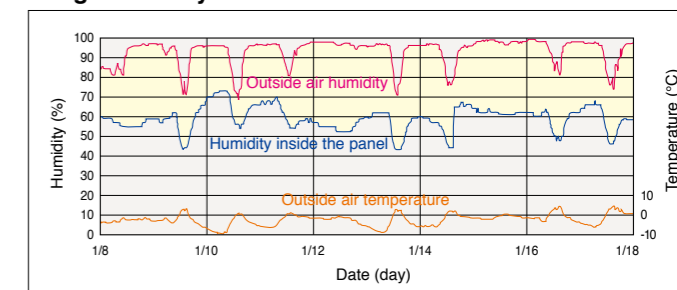

Optional Parts

Rainproof cover: This product prevents rain drops and insects from entering the moisture discharging hole when the dehumidifier is used in an outdoor panel.
Adapter set: This product provides round moisture discharging holes and prevents rain drops or insects from entering the holes when a dehumidifier is used in an already installed outdoor panel. A special vent cover is included.

Options

Product name	Model name	Compatible model
Rainproof cover	For RDH-3J1	RDH-3J1, RDH-3P1
	For RDH-5J1	RDH-5J1, RDHC-5J1, RDHB-5J1, MDL-3, MDL-5
	For RDH-7J1	RDH-7J1, RDHC-7J1, RDHC-5P1, RDHC-7P1, RDHB-7J1, MDL-7
	For RDH-10J1	RDH-10J1, RDHC-10J1, RDHB-10J1
Adapter set	For RDH-10J2	RDH-10J2, RDHC-10J2
	For RDH-5J1	RDH-5J1, RDHC-5J1
	For RDH-7J1	RDH-7J1, RDHC-7J1
	For RDH-10J1	RDH-10J1, RDHC-10J1
	For RDH-10J2	RDH-10J2, RDHC-10J2

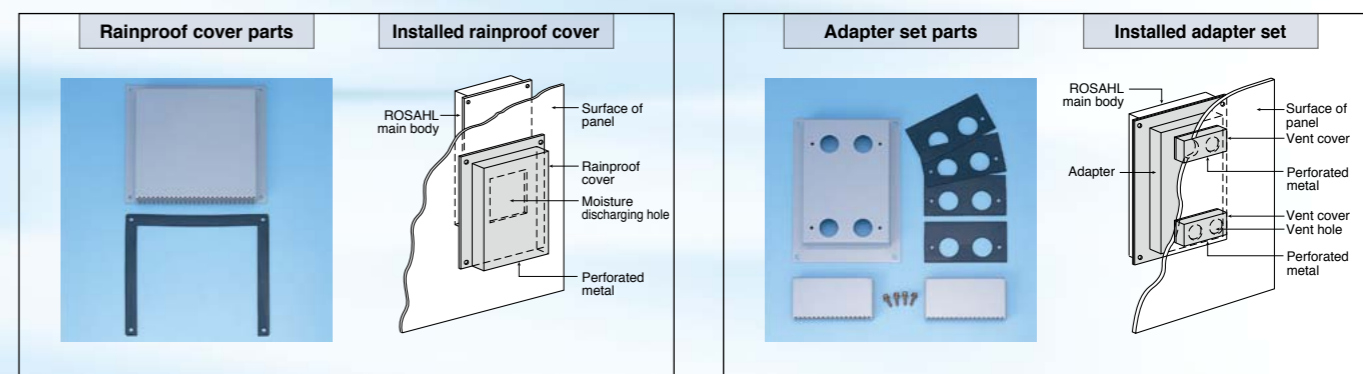

How to install dehumidifying element

Follow these instructions to ensure airtightness when installing a dehumidifying element.

How to install small dehumidifying element

[PD2, PD3]

Make a screw hole for an M12 (P0.5) mm screw on the container on which you will install the dehumidifying element. Insert a packing into the hole and slowly screw in the screw.
(Specified torque: 0.25 to 0.39 N·m)
The packing is not included.

Installation dimensions(Unit:mm)

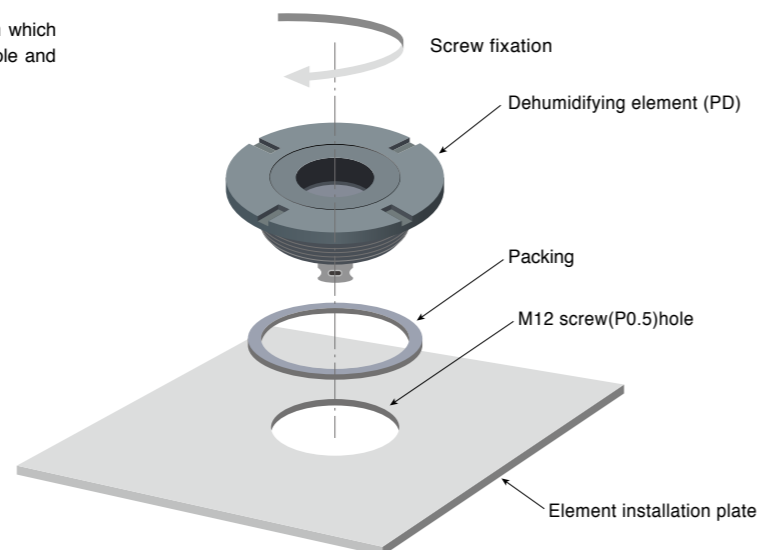
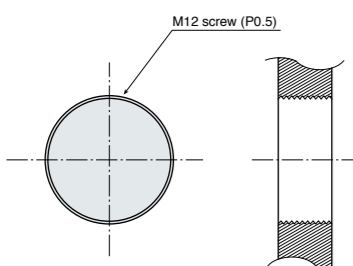

How to install small dehumidifying element

[RD3, RD4]

Make a square hole 12.5 mm x 12.5 mm on the container, insert the included packing and attach the dehumidifying element with four M2 screws.
(Specified torque: Max. 0.18 N·m)

Installation dimensions(Unit:mm)

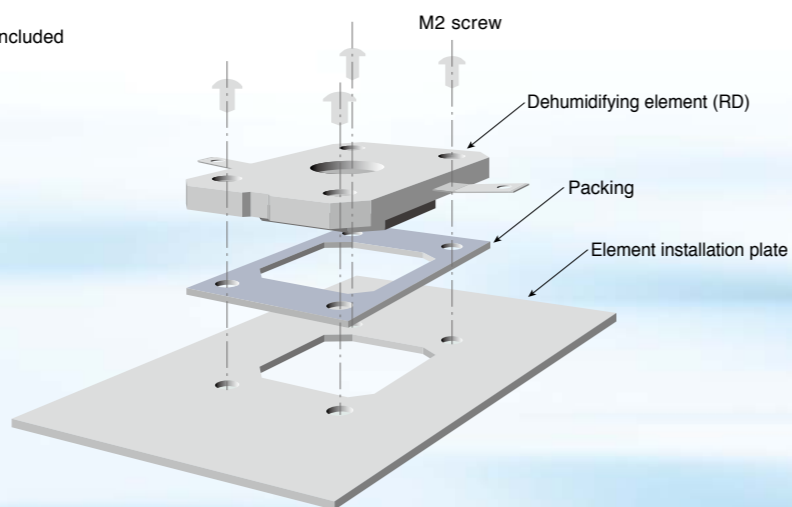
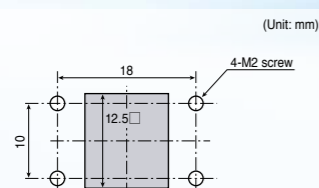

How to install thin dehumidifying element

[MDL-3, MDL-5, MDL-7]

- As shown in the right figure, fit packing to both sides of the dehumidifying element, attach the retainer plate on the top and fasten at around four points around the edge with M4 screws. If the necessary distance is not secured between the connecting terminal of dehumidifying element and the panel surface, attach the dehumidifying element to an element installation plate or such other plate and then install to the panel surface.
- The packings used should be made from PTFE (polytetrafluoroethylene) series and have hardness of approximately 50.
- When installing in an outdoor panel, avoid interference with the attaching screws of the rainproof cover.

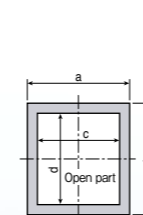
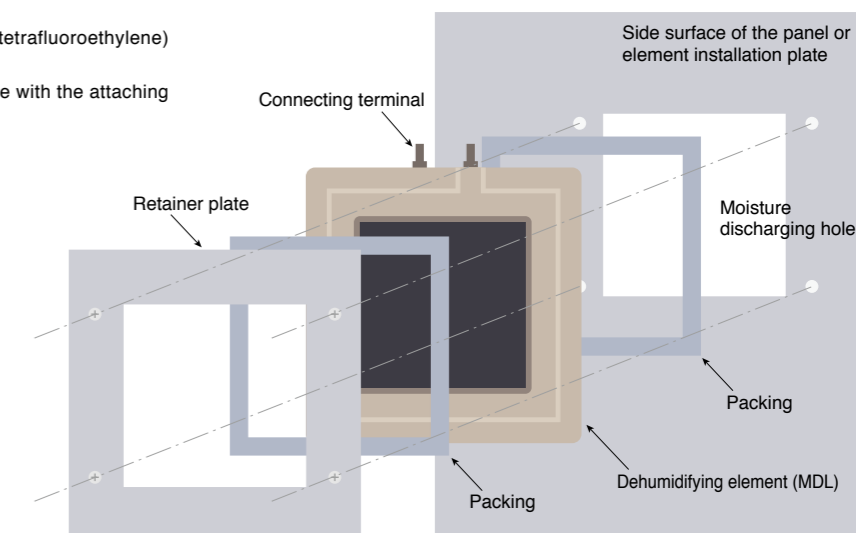

Material: PTFE series
Hardness: Approximately 50
Thickness: 2 mm

Figure 1: Packing

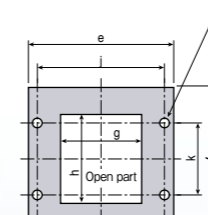

Material: SUS
Thickness: 3 mm

Figure 2: Retainer plate

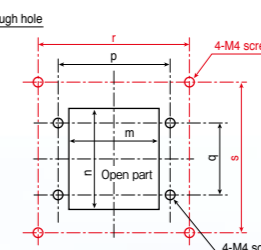

Black: Dimensions of thin element installation hole
Red: Dimensions of rainproof cover installation hole

Figure 3: Dimensions of installation holes

Installation dimensions of thin dehumidifying element (recommended)

Model name	Packing (Figure 1)				Retainer plate (Figure 2)				Main body insatallation dimensions (Figure 3)				Rainproof cover insatallation dimensions (Figure 3)		Rainproof cover model no.		
	a	b	c	d	e	f	g	h	j	k	m	n	p	q		r	s
MDL-3	45	70	30	55	80	75	30	55	70	40	30	55	70	40	135	125	For RDH-5J1
MDL-5	70	70	55	55	105	75	55	55	95	40	55	55	95	40	135	125	
MDL-7	90	90	75	75	125	95	75	75	115	60	75	75	115	60	175	150	

For the rainproof cover and adapter set, see page 9.

How to install dehumidifier

Install directly or using an adapter. See the figures and table below before making holes.

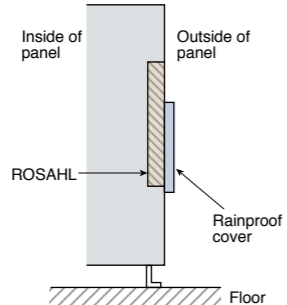
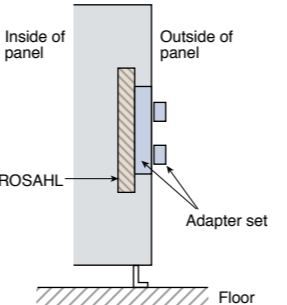
Installation method	Direct installation method	Adapter installation method
	<p>Make a square moisture discharging hole on the side of the panel and directly install the dehumidifier. Always use an optional rainproof cover for outdoor panels.</p> 	<p>Use an optional adapter set for installation. This method is usually used when it is not possible to make a square moisture discharging hole on the surface itself, for example when installing to an existing panel.</p> 

(2) Molded type

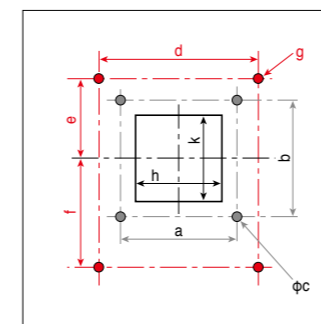

Figure 1

●Main body and rainproof cover

Installation method	Model name	Main body installation dimensions			Rainproof cover installation dimensions				Moisture discharging hole dimensions		Remarks
		a	b	c	d	e	f	g	h	k	
Direct installation method	RDH-3P1	57	73	5	85	57.5	57.5	M4 screw	35	35	Figure 1
	RDHC-5P1	120	106	6	175	67.5	82.5	M4 screw	75	75	
	RDHC-7P1										

* On RDHC-5P1 and 7P1, use a rainproof cover (optional) for RDH-7J1.
* On RDH-3P1, use a rainproof cover (optional) for RDH-3J1.

For the rainproof cover and adapter set, see page 9.

Panel boring dimensions

(1) humidity controller embedded type and general type

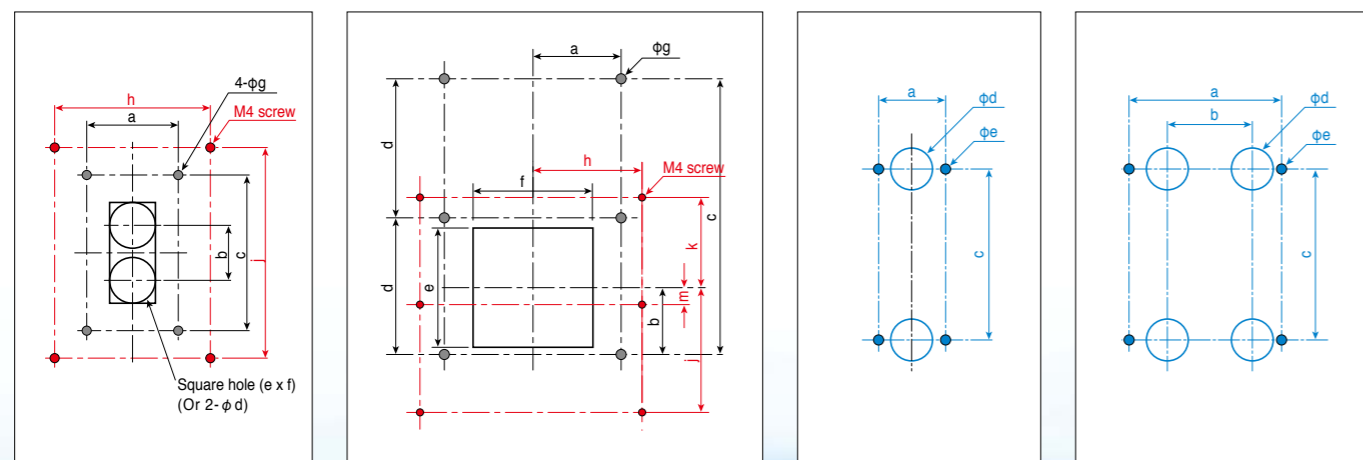

Figure 1

Figure 2

Figure 3

Figure 4

●Main body and rainproof cover

Installation method	Model name	Main body insatallation dimensions							Rainproof cover insatallation dimensions ^{*1}				Remarks
		a	b	c	d	e	f	g	h	j	k	m	
Direct installation method	RDH-3J1	50	30	85	(25)	25	55	5	85	115	—	—	Figure 1
	RDH-5J1·RDHC-5J1	52.5	39	160	—	70	70	5	67.5	72.5	52.5	—	Figure 2
	RDH-7J1·RDHC-7J1	65	50	185	—	95	95	6	87.5	85	65	—	
	RDH-10J1·RDHC-10J1	80	62.5	225	—	125	125	6	112.5	100.5	79.5	—	
Adapter installation method	RDH-5J1·RDHC-5J1	40	—	100	18	6.5	—	—	—	—	—	—	Figure 3
	RDH-7J1·RDHC-7J1	90	45	115	25	7.5	—	—	—	—	—	—	Figure 4
	RDH-10J1·RDHC-10J1	90	45	150	25	7.5	—	—	—	—	—	—	
	RDH-10J2·RDHC-10J2	90	45	260	30	7.5	—	—	—	—	—	—	

Note: *1 Not necessary when a rainproof cover is not used.

(3) Separate type

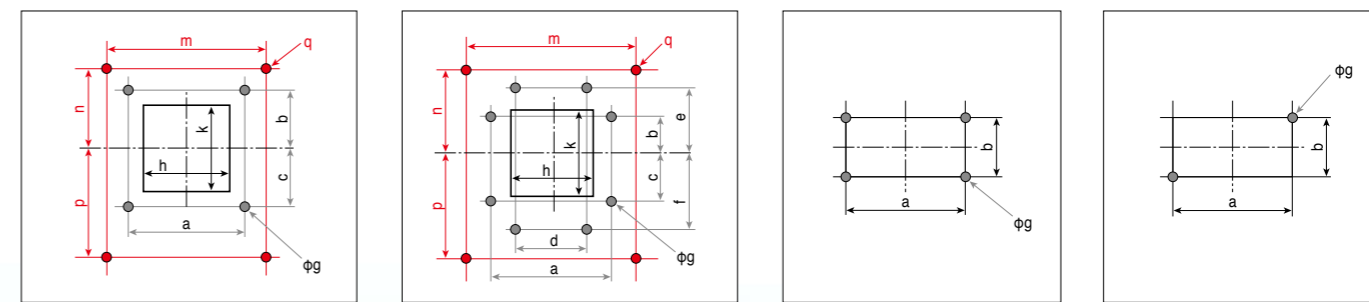

Figure 1

Figure 2

Figure 3

Figure 4

●Element unit, Power supply unit, Humidity controller unit (Unit: mm)

Unit name	Model name	Installation dimensions							Moisture discharging hole dimensions		Remarks
		a	b	c	d	e	f	g	h	k	
Element unit	S-5J1	91	40	60	—	—	—	5	60	67	Figure 1
	S-7J1	118	50	50	—	—	—	5	80	87	Figure 1
	S-10J1	148	43.5	56.5	100	75	88	5	110	117	Figure 2
Power supply unit	D-3006JW	173	84	—	—	—	—	5	—	—	Figure 3
	D-3010JW	216	84	—	—	—	—	5	—	—	Figure 3
Humidity controller unit	C-M1J	102	40	—	—	—	—	5	—	—	Figure 4

●Rainproof cover

Installation method	Applicable model name ^{*1}	Rainproof cover installation dimensions				Remarks
		m	n	p	q	
Direct installation method	For RDH-5J1	135	55	70	M4 screw	Figure 1
	For RDH-7J1	175	65	85	M4 screw	
	For RDH-10J1	225	90	90	M4 screw	

*1 Select a suitable rainproof cover for the element unit.
Example: S-5J1 -> For RDH-5J1

For the rainproof cover and adapter set, see page 9.

Precautions
for use of
dehumidifying
elements

1. Attach a protective cover when necessary to prevent hands or objects from coming into contact with the dehumidifying/humidifying surface of the element.
2. Check the installation direction carefully before installation.
Installing in the opposite direction will reverse dehumidification and humidification, which may result in an adverse effect on the contents in the container.
3. Strictly follow the following instructions about power supply to the element.
 - (1) DO NOT reverse the polarity. Please check the indication of polarity for the product. (Attach a polarity indication LED on the outside if necessary.)
Inverting the polarity will reverse dehumidification and humidification, which may result in an adverse effect on the contents in the container and also will cause chemical reaction consuming the porous electrode at the cathode side and leading to damage of the element.
 - (2) The dehumidifying element naturally causes a relatively large starting current when the power is turned on. Therefore, the specifications below are recommended for the power source.
 - (3) Use a dedicated power source for each dehumidifying element.
(When multiple dehumidifying elements are connected in series or parallel, the breakage of one element may cause all other elements to be disabled.)

Recommended power source specifications

	MDL-3	MDL-5	MDL-7	PD2/PD3/RD3/RD4
Rated output voltage	3 VDC			
Rated output current	2A	3A	5A	500mA
Overcurrent protection function (constant or fold-back current limiting)	Note: When fold-back current limiting is employed, the dehumidifying element may not function correctly.			
Overvoltage protection function	<input type="checkbox"/>	<input type="checkbox"/>	<input type="checkbox"/>	<input type="checkbox"/>
Output voltage variation	0.1 V or less			
Ripple noise	0.2 V or less			
Others	In accordance with the specifications of commercially available power sources			

4. The container must have a sealed structure. If the container is made of moisture-permeable material, the results may not be satisfactory.
5. It is preferable that the element is installed in the center of the inner side surface of the container with packing to ensure airtightness of the container.
(Do not install on the top or bottom surface)
6. If there is rubber packing or a similar material that contains an antioxidant, crystalline substances may form on the element.
Careful evaluation of material is necessary when selecting a packing
7. Sealing agents should not be silicon-based.
(Silicon-based sealing agents generate oxime gas and siloxane gas during hardening, which quickly degrades the performance of the dehumidifying element.)
Recommended products: modified silicon caulk (Konishi) or acrylic caulk (Konishi)
Modified silicon caulk is mainly composed of polyurethane.
Consult us if using a sealing agent not specified above.
8. When using outdoors:
MDL-3, MDL-5, MDL-7: Be sure to attach a rainproof cover with an anti-insect net (perforated metal) (optional) to protect from water or insects.
PD2, PD3, RD3, RD4: Cover the element with a cover or moisture-permeable sheet to prevent it from getting wet.
9. Keep the moisture discharging side unsealed and well ventilated.
10. Do not use with vapor phase corrosion inhibitor or insect repellent. Do not use in an environment with a lot of organic gas.
11. Consult us if there is dust or oil mist in the environment where the product will be used.
12. Do not attempt to disassemble, repair or modify the product, as this may damage it.

Precautions
for use of
dehumidifier

1. Check the installation direction carefully before installation.
Installing in the opposite direction will reverse dehumidification and humidification, which may result in an adverse effect on the contents in the container.
2. The container must have a sealed structure. If the container is made of moisture-permeable material, the results may not be satisfactory
3. It is preferable that the product is installed in the center of the inner side surface of the container. (Do not install on the top or bottom surface)
4. If there is rubber packing or a similar material that contains an antioxidant, crystalline substances may form on the element.
Careful evaluation of material is necessary when selecting a packing
5. Sealing agents should not be silicon-based.
(Silicon-based sealing agents generate oxime gas and siloxane gas during hardening, which quickly degrades the performance of the dehumidifying element.)
Recommended products: modified silicon caulk (Konishi) or acrylic caulk (Konishi)
Modified silicon caulk is mainly composed of polyurethane.
Consult us if any questions.
6. Do not expose the moisture discharging hole to water.
When using outdoors, be sure to attach a rainproof cover with anti-insect net (perforated metal) (optional) to protect from water or insects.
7. Keep the moisture discharging side unsealed and well ventilated.
8. Do not use with vapor phase corrosion inhibitor or insect repellent. Do not use in an environment with a lot organic gas.
9. Consult us if there is dust or oil mist in the environment where the product will be used.
10. Do not attempt to disassemble, repair or modify the product, as this may damage it.